

iMatrix H44AM

4x4 HDMI 2.0 Matrix with Audio Matrix/ Downscaling/

AOC Supported

User Manual V1.2

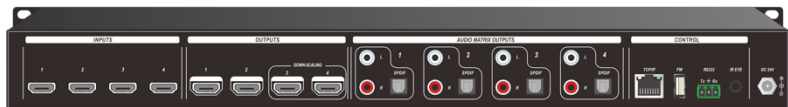

All Rights Reserved

Preface

Read this user manual carefully before using the product. Pictures shown in this manual are for reference only. Different models and specifications are subject to real product.

This manual is only for operation instruction, please contact the local distributor for maintenance assistance. The functions described in this version were updated till September, 2019. In the constant effort to improve the product, we reserve the right to make functions or parameters changes without notice or obligation. Please refer to the dealers for the latest details.

FCC Statement

This equipment generates, uses and can radiate radio frequency energy and, if not installed and used in accordance with the instructions, may cause harmful interference to radio communications. It has been tested and found to comply with the limits for a Class B digital device, pursuant to part 15 of the FCC Rules. These limits are designed to provide reasonable protection against harmful interference in a commercial installation.

Operation of this equipment in a residential area is likely to cause interference, in which case the user at their own expense will be required to take whatever measures may be necessary to correct the interference.

Any changes or modifications not expressly approved by the manufacture would void the user's authority to operate the equipment.



SAFETY PRECAUTIONS

To ensure the best from the product, please read all instructions carefully before using the device. Save this manual for further reference.

- Unpack the equipment carefully and save the original box and packing material for possible future shipment
- Follow basic safety precautions to reduce the risk of fire, electrical shock and injury to persons.
- Do not dismantle the housing or modify the module. It may result in electrical shock or burn.
- Using supplies or parts not meeting the products' specifications may cause damage, deterioration or malfunction.
- Refer all servicing to qualified service personnel.
- To prevent fire or shock hazard, do not expose the unit to rain, moisture or install this product near water.
- Do not put any heavy items on the extension cable in case of extrusion.
- Do not remove the housing of the device as opening or removing housing may expose you to dangerous voltage or other hazards.
- Install the device in a place with fine ventilation to avoid damage caused by overheat.
- Keep the module away from liquids.
- Spillage into the housing may result in fire, electrical shock, or equipment damage. If an object or liquid falls or spills on to the housing, unplug the module immediately.
- Do not twist or pull by force ends of the cable. It can cause malfunction.
- Do not use liquid or aerosol cleaners to clean this unit. Always unplug the power to the device before cleaning.
- Unplug the power cord when left unused for a long period of time.
- Information on disposal for scrapped devices: do not burn or mix with general household waste, please treat them as normal electrical wastes.

Table of Contents

1. Product Introduction	1
1.1 Features	1
1.2 Package List	1
2. Specification	2
3. Panel Description	4
3.1 Front Panel	4
3.2 Rear Panel	5
4. System Connection	6
4.1 Usage Precaution	6
4.2 System Diagram	6
5. Panel Control	7
5.1 I/O connection switching	7
5.2 I/O connection Inquiry	7
5.3 LOCK Function	7
5.4 PRESET RECALL Function	7
5.5 CLEAR Button	8
6. IR Remote Control	8
7. GUI Control	9
7.1 Switching Tab	10
7.2 Audio Tab	11
7.3 Configuration Tab	12
7.4 CEC Tab	14
7.5 RS232 Tab	16
7.6 Interface Tab	17
7.7 Network Tab	18
7.8 Access Tab	18
7.9 GUI Upgrade	19
8. RS232 Control	20
8.1 Installation/uninstallation of RS232 Control Software	20
8.2 Basic Settings	20

4x4 HDMI 2.0 Matrix with Audio Matrix/ Downscaling/ AOC Supported

8.3 RS232 Communication Commands	21
8.3.1 System Commands	21
8.3.2 Control Management	21
8.3.3 Query Commands	22
8.3.4 Lock/unlock Commands	24
8.3.5 Audio Commands	24
8.3.6 HDCP Compliance	25
8.3.7 EDID Management	26
8.3.8 CEC Control	28
9. Firmware Upgrade	30
10. Troubleshooting and Maintenance	31
11. Customer Service	33

1. Product Introduction

The H44AM is a professional 4x4 HDMI 2.0 Matrix Switcher with Audio Matrix. It includes 4 HDMI inputs, 4 HDMI outputs and the last two outputs with down-scaling function, which is designed for switching two HDMI2.0 and HDCP2.3 compliant signals. It also features 4 SPDIF and 4 analog audio outputs for audio matrix.

The matrix switcher features comprehensive EDID management and advanced HDCP handing to ensure maximum functionality with a wide range of video sources.

The matrix switcher not only supports bi-directional IR, RS232 extension but also has IR, RS232, and TCP/IP control options.

1.1 Features

- 4x4 HDMI 2.0 Matrix Switcher.
- Supports 4K/60 4:4:4, HDR, HDCP2.3 compliant.
- Audio Matrix, audio out can de-embedded from arbitrary input or output.
- Individual volume adjustment on each L+R output.
- Supports 4K to 1080p down-scaling up to 2 outputs.
- HDMI out provides 2.5W to power Active Optical Cable (AoC).
- HDMI Output support up to 5V500mA for AoC cable
- Controllable by front panel, IR, RS232 and TCP/IP.

1.2 Package List

- 1 x H44AM
- 2 x Mounting Ears with 6 Screws
- 4 x Plastic Cushions
- 1 x IR Remote
- 1 x IR Receiver
- 1 x RS232 Cable (3-pin to DB9)
- 1 x Power Adaptor (24V DC 1.25A)
- 1 x User Manual

Note: Please contact your distributor immediately if any damage or defect in the components is found.

2. Specification

Video	
Video Input	(4) HDMI
Video Input Connector	(4) Type-A female HDMI
Video input Video Resolution	Up to 4K@60Hz 4:4:4
Video Output	(4) HDMI
Video Output Connector	(4) Type-A female HDMI,
Video output Video Resolution	Up to 4K@60Hz 4:4:4
HDMI Output	Supports up to 5V500mA for AoC cable
HDMI Version	Up to 2.0
HDCP Version	Up to 2.3
HDMI Audio Signal	LPCM 7.1 audio, Dolby Atmos®, Dolby® TrueHD, Dolby Digital® Plus, DTS:X™, and DTS-HD® Master Audio™ pass-through.
Digital Audio Output	
Output	(4) Digital SPDIF audio
Output Connector	(4) Toslink connector
Digital SPDIF Audio Format	Supports PCM, Dolby Digital, DTS, DTS-HD
Frequency Response	20 Hz to 20 kHz, ±1dB
Max Output level	±0.05dBFS
THD+N	< 0.05%, 20 Hz – 20 kHz bandwidth, 1 kHz sine at 0dBFS level (or max level)
SNR	> 90dB, 20Hz-20 kHz bandwidth
Crosstalk Isolation	< -70 dB, 10 kHz sine at 0dBFS level (or max level before clipping)
Noise	-90dB
Analog Audio Output	
Output	(4) Analog L/R Audio
Output Connector	(4) L&R (RCA)
Digital SPDIF Audio Format	PCM 2CH
Frequency Response	20 Hz to 20 kHz, ±1dB
Max output level	2.0Vrms ± 0.5dB. 2V = 16dB headroom above -10dBV (316 mV) nominal consumer line level signal
THD+N	< 0.05%, 20 Hz – 20 kHz bandwidth, 1 kHz sine at 0dBFS level (or max level)
SNR	> 80dB, 20Hz-20 kHz bandwidth
Crosstalk Isolation	< -80 dB, 10 kHz sine at 0dBFS level (or max level before clipping)
L-R Level deviation	< 0.05 dB, 1 kHz sine at 0dBFS level (or max level before clipping)
Frequency Response Deviation	< ± 0.5dB 20Hz - 20KHz
Output Load Capability	1k ohm and higher (supports 10x paralleled 10k ohm loads)

4x4 HDMI 2.0 Matrix with Audio Matrix/ Downscaling/ AOC Supported

Noise	-80dB
Control	
Control Port	(1) IR EYE, (1) RS232, (1) FIRMWARE, (1) TCP/IP
Control Connector	(1) 3.5mm jack, (1) 3-pin terminal block, (1) USB-A, (1) RJ45,
General	
Transmission Distance	4K/60Hz/444 5m,4K/60Hz/420 10m,1080P 15m
Bandwidth	18Gbps
Operation Temperature	-5~ +55℃
Storage Temperature	-25 ~ +70℃
Relative Humidity	10%-90%
External Power Supply	Input: AC 100~240V, 50/60Hz; Output: 24V DC 1.25A
Maximum Power Consumption	18.3W
Dimension (W*H*D)	436.4mm*44mm*236mm
Net Weight	2.6kg

Video Resolution Down-scaling

The product supports video resolution down-scaling, the 4K input can be automatically degraded to 1080p output for compatibility with 1080p display, shown in the below chart.

#	Input			Output	
	Resolution	Refresh	Color Space	Downscale	1080p Specs
1	3840x2160	60	4:4:4	Support	1080p@60Hz 4:4:4
2	3840x2160	30	4:4:4	Support	1080p@30Hz 4:4:4
3	3840x2160	24	4:4:4	Support	1080p@24Hz 4:4:4
4	3840x2160	60	4:2:0	Support	1080p@60Hz 4:4:4
5	3840x2160	30	4:2:0	Support	1080p@30Hz 4:4:4
6	3840x2160	24	4:2:0	Support	1080p@24Hz 4:4:4
7	3840x2160	60	4:2:2	Not Support	N/A
8	3840x2160	30	4:2:2	Not Support	N/A
9	3840x2160	24	4:2:2	Not Support	N/A

Note: Only last two outputs (output 3 and output 4) have down-scaling function.

3. Panel Description

3.1 Front Panel

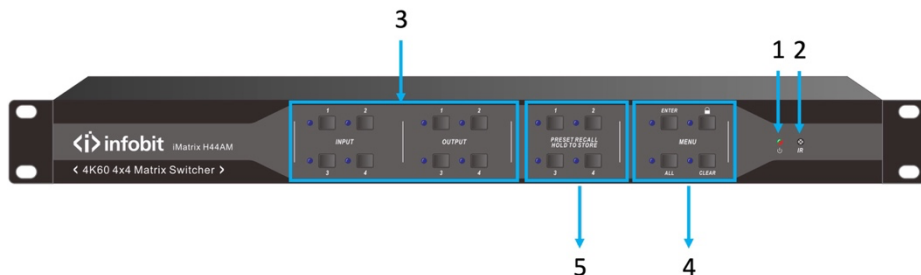

No.	Name	Description
①	Power Indicator	<ul style="list-style-type: none"> • Illuminates green when device powered on; • Turns red in standby mode.
②	IR sensor	Built-in IR sensor, receives IR signal sent from IR remote.
③	INPUT selector button OUTPUT selector button	<ul style="list-style-type: none"> • Total 4 input selector buttons, press one of buttons to switch input source. • Total 4 output selector buttons, press the buttons to select output channel.
④	ENTER button	Confirm operation.
	LOCK button	Press this button for 3 seconds to lock/unlock all front buttons.
	ALL button	Select all outputs to convert an input to all outputs: → Press INPUTS 1 + ALL + ENTER
	CLEAR button	Withdraw button.
⑤	PRESET RECALL HOLD TO STORE	<ul style="list-style-type: none"> • Press and hold the button 1~4 to save the current switching status to the corresponding preset 1~4. • Press the button 1~4 to recall the saved preset 1~4.

3.2 Rear Panel



No.	Name	Description
①	INPUTS	HDMI input ports, 4 in total, connects with HDMI sources.
②	OUTPUTS	4 in total, connects with HDMI displays. The latter four HDMI ports have down-scaling function.
③	AUDIO MATRIX OUTPUTS	SPDIF: audio output ports for de-embedded HDMI audio, 4 in total. L&R (RCA): audio output ports for de-embedded HDMI audio, 4 pairs in total.
④	IR EYE	Connects with external IR receiver for using the IR remote to control the Matrix Switcher.
	RS232	3-pin terminal block to connect the RS232 control device (e.g. PC) or a device to be controlled by RS232 commands.
	FIREWARE	USB-A port for updating firmware.
	TCP/IP	RJ45 port to connect the control device (e.g. PC) to control the matrix by GUI.
⑤	DC 24V	Connect with 24VDC 1.25A power adaptor.

4. System Connection

4.1 Usage Precaution

- Make sure all components and accessories included before installation.
- System should be installed in a clean environment with proper temperature and humidity.
- All of the power switches, plugs, sockets, and power cords should be insulated and safe.
- All devices should be connected before power on.

4.2 System Diagram

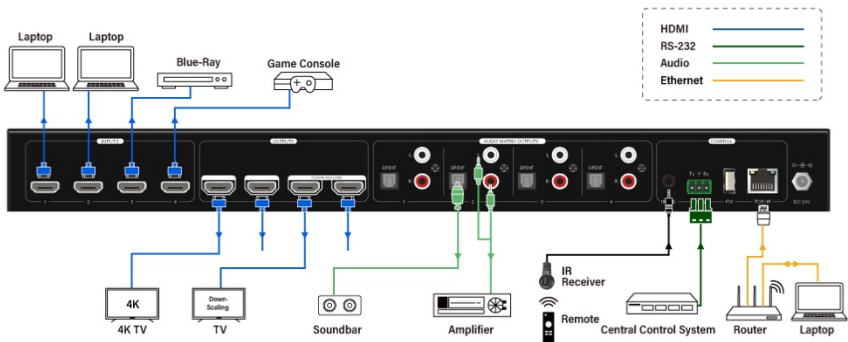

5. Panel Control

5.1 I/O connection switching

The front panel features four input selection buttons and four output selection buttons for switching I/O connection.

1) To convert 1 input to 1 output:

Example: Input 1 to Output 3

→ Press **INPUTS 1 + OUTPUTS 3 + ENTER** button.

2) To convert 1 input to 2~3 outputs:

Example: Input 1 to Output 2, Output 3, Output 4.

→ Press **INPUTS 1 + OUTPUTS 2, Output 3, Output 4 + ENTER** button.

3) To convert 1 input to 4 outputs:

Example: Convert Input 2 to all outputs

→ Press **INPUTS 2 + ALL** button + **ENTER** button.

NOTE: Indicators of the pressed buttons will blink blue for three times if the conversion is done, then it will be off. If the conversion failed, they will be off immediately.

5.2 I/O connection Inquiry

Press **OUTPUTS** button 1, 2, 3 or 4 to inquiry its corresponding input, and then the indicator of the input button will turn blue.

5.3 LOCK Function

Long press the **LOCK** button for three seconds, all buttons on the front panel disable to work. And then long press the **LOCK** button for three seconds again or unlock on GUI control, the front panel button will unlock.

5.4 PRESET RECALL Function

Press and hold the **PRESET 1~4** at least three seconds to save the current switching status to the corresponding preset 1~4.

Press the **PRESET 1~4** to recall the saved preset 1~4.

Note: The matrix switcher supports six presets, but only preset 1~4 can be saved and recalled by button control. Please manage other preset by GUI control or RS232 control.

5.5 CLEAR Button

Please press the **CLEAR** button if want to withdraw an operation before the **ENTER** button comes into effect, meanwhile, the matrix will return to the previous status.

6. IR Remote Control

The Matrix Switcher features one built-in IR receiver to receive IR signal from IR remote to enable IR control. If the external IR receiver or other IR control device need to be used, the IR EYE port on rear panel can be connected.

① Standby button:

Press it to enter/ exit standby mode.

② INPUTS:

Input channel selection buttons, same with the corresponding front panel buttons

③ OUTPUTS:

Output channel selection buttons, same with the corresponding front panel buttons.

④ Menu buttons:

- **ALL**: Select all inputs/outputs.

To convert an input to all outputs:

Example: Input 1 to all Outputs:

→ Press INPUTS 1 + ALL + ENTER

- **EDID management button**:

1) One input port follows the EDID data from one output port.

Example: Input 2 learns EDID data from output 4:

→ Press EDID + INPUTS 2 + OUTPUTS 4+ ENTER

2) All input ports learn EDID data from one output port.

Example: All input ports learn EDID data from output 3:

→ Press EDID + ALL + OUTPUTS 3 + ENTER

- **CLEAR**: Withdraw button.

- **ENTER**: Confirm operation.

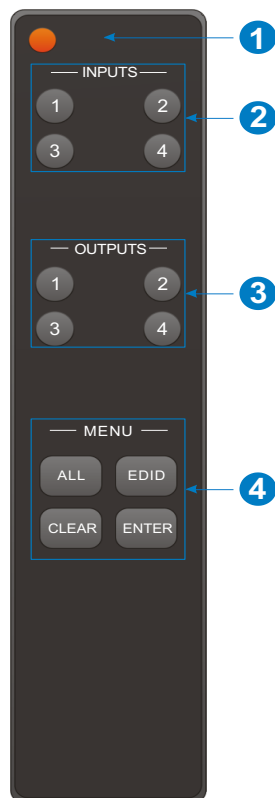

7. GUI Control

The matrix can be controlled via TCP/IP. The default IP settings are:

IP Address: 192.168.0.178

Subnet Mask: 255.255.255.0

Gateway: 192.168.0.1

Type **192.168.0.178** in the internet browser, it will enter the below log-in webpage:

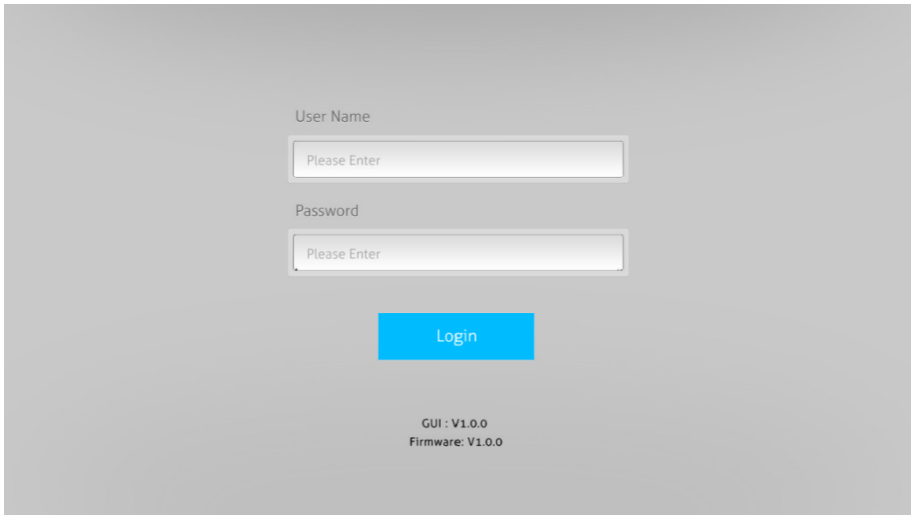

Username: admin

Password: admin

Type the user name and password, and then click **Login** to enter the section for video switching.

7.1 Switching Tab



Use the 4x4 button grid on the page to set which inputs are directed to which outputs. For example, clicking the button on the Input 1 row and Output 1 column, directs input 1 to output 1.

Use the 6 numbered buttons under scene area to save and load layout presets.

- To save a given layout, first click one of the numbered buttons, then click the **Save** button.
- To load a previously saved layout, first click one of the numbered buttons, then click the **Recall** button.



7.2 Audio Tab

1) Audio Setting

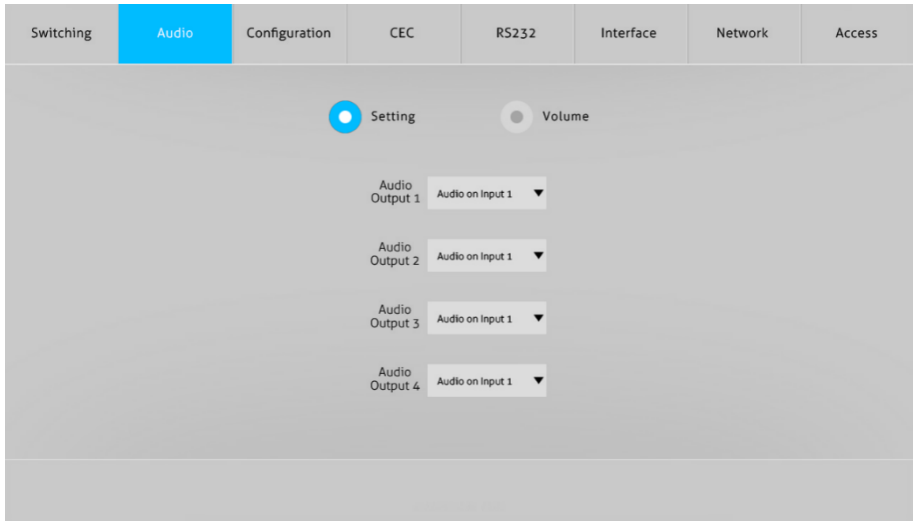

- There are eight audio sources can be selected for four digital SPDIF output ports.

Audio Output Ports	Audio Sources	
	Input Breakout	Output Breakout
SPDIF 1 & Analog 1	Audio on Input 1	Audio on Output 1
SPDIF 2 & Analog 2	Audio on Input 2	Audio on Output 2
SPDIF 3 & Analog 3	Audio on Input 3	Audio on Output 3
SPDIF 4 & Analog 4	Audio on Input 4	Audio on Output 4

2) Audio Volume

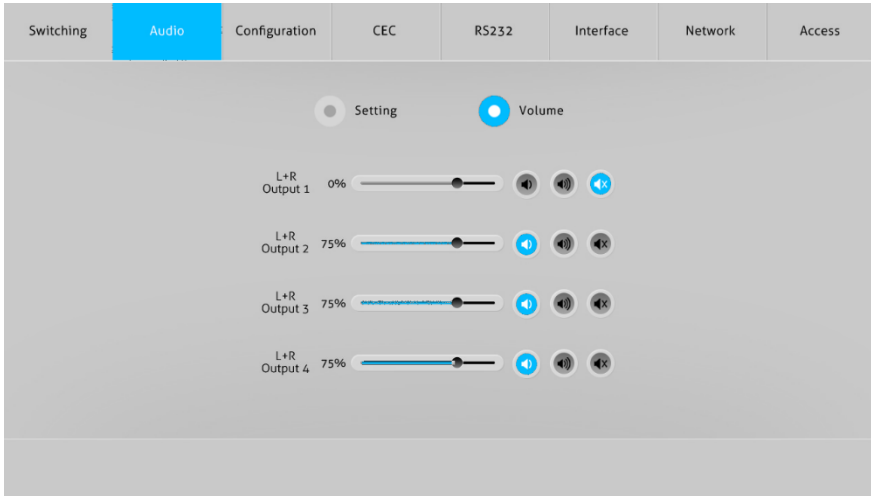

- Four pairs analog L/R audio to control their outputs volume.

7.3 Configuration Tab

1) EDID Copy

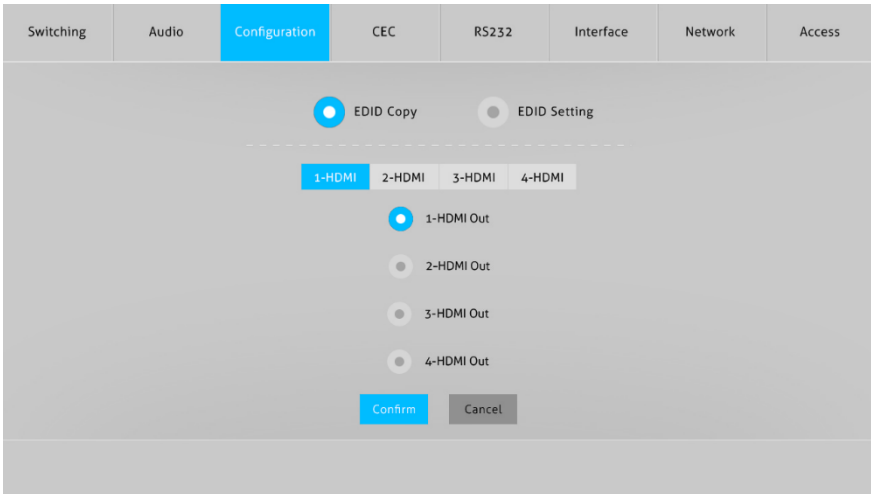

- Copy the EDID of the selected output device to one or more input source device.

2) EDID Setting

The screenshot shows the 'EDID Setting' interface. At the top, there are tabs for 'Switching', 'Audio', 'Configuration' (selected), 'CEC', 'RS232', 'Interface', 'Network', and 'Access'. Below these, there are two radio buttons: 'EDID Copy' (unselected) and 'EDID Setting' (selected). A dashed line separates this from the EDID options. There are four tabs for '1-HDMI', '2-HDMI', '3-HDMI', and '4-HDMI', with '1-HDMI' selected. The options are arranged in a grid:

Option	1-HDMI	2-HDMI	3-HDMI	4-HDMI
1920x1080@60 8bit Stereo	<input type="radio"/>	<input type="radio"/>	<input type="radio"/>	<input type="radio"/>
1920x1080@60 8bit High Definition Audio	<input type="radio"/>	<input type="radio"/>	<input type="radio"/>	<input type="radio"/>
3840x2160@30Hz 8bit Stereo Audio	<input type="radio"/>	<input type="radio"/>	<input type="radio"/>	<input type="radio"/>
3840x2160@30Hz Deep Color High Definition Audio	<input type="radio"/>	<input type="radio"/>	<input type="radio"/>	<input type="radio"/>
	<input checked="" type="radio"/>	<input type="radio"/>	<input type="radio"/>	<input type="radio"/>

The 'User-defined' option is selected, and a text box next to it contains '.bin'. Below the text box is an 'Apply' button. At the bottom of the interface are 'Confirm' and 'Cancel' buttons.

- Select the compatible built-in EDID for the selected input source.
- Upload user-defined EDID by the below steps:
 - 1) Prepare the EDID file (.bin) on the control PC.
 - 2) Select the **User-defined**.
 - 3) Click the box , and then select the EDID file (.bin) according the tooltip.
 - 4) Click **Apply** to upload the user-defined EDID, and then click **Confirm** to save setting.

7.4 CEC Tab

If the input source devices, output display devices support CEC, they can be controlled via the following CEC interface.

1) Input Source Device Control

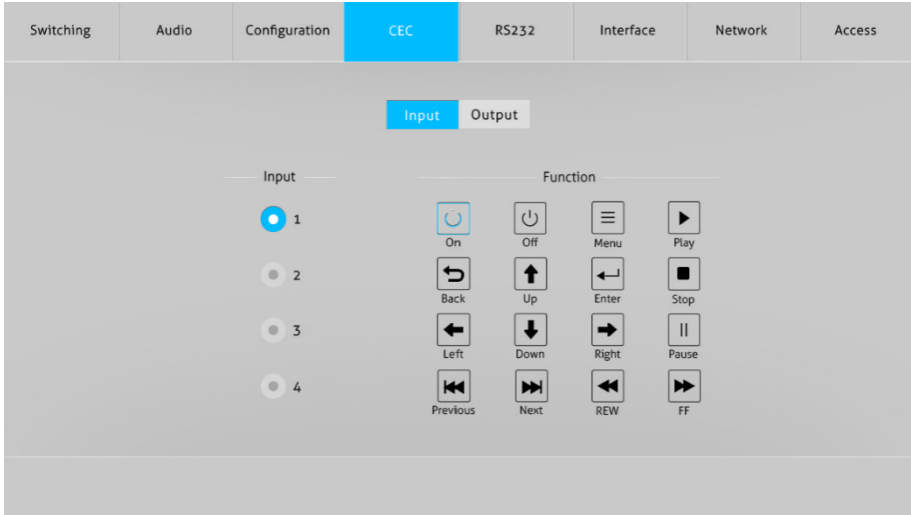

- Select one input source device to be controlled, and then press function buttons.

Note: It can not control two or more input source devices simultaneously.

2) Output Display Device Control



- Select one output device to be controlled, and then press function buttons.

Note: It can not control two or more output devices simultaneously.

7.5 RS232 Tab

Switching	Audio	Configuration	CEC	RS232	Interface	Network	Access
<p>ASCII <input checked="" type="radio"/> HEX <input type="radio"/></p> <p>Baud Rate: 9600 ▼</p> <p>Command Ending: NULL ▼</p> <p>Command: xxxxxx</p> <p><input type="button" value="Confirm"/> <input type="button" value="Cancel"/></p>							

- ASCII or HEX command format can be selected.
- Baud Rate: Supports 2400, 4800, 9600, 19200, 38400, 57600 or 115200.
- Command Ending: NULL, CR, LF or CR+LF can be chosen.
- Command: Type the command in this box to control the third-party device which is connected to the RS232 port of the switcher.

7.6 Interface Tab

Switching	Audio	Configuration	CEC	RS232	Interface	Network	Access
-----------	-------	---------------	-----	-------	-----------	---------	--------

Title Bar Label:

Button Labels:

Input	Output
1: <input type="text" value="Input 1"/>	1: <input type="text" value="Output 1"/>
2: <input type="text" value="Input 2"/>	2: <input type="text" value="Output 2"/>
3: <input type="text" value="Input 3"/>	3: <input type="text" value="Output 3"/>
4: <input type="text" value="Input 4"/>	4: <input type="text" value="Output 4"/>

- Modify the title bar label.
- Modify the button labels.

7.7 Network Tab

The screenshot shows the 'Network' configuration page. At the top, there is a navigation bar with tabs: Switching, Audio, Configuration, CEC, RS232, Interface, Network (selected), and Access. The main content area displays the MAC Address as 44-33-4C-C9-35-12. Below this, there are two radio buttons for network configuration: 'DHCP' (selected) and 'Static IP'. Under the 'Static IP' section, there are input fields for IP Address (192.168.0.178), Subnet Mask (255.255.255.0), and Gateway (192.168.0.1). A 'Confirm' button is located at the bottom of the form.

- Static IP or Dynamic Host Configuration Protocol (DHCP).
- Modify the static IP Address, Subnet Mask, and Gateway.

7.8 Access Tab

The screenshot shows the 'Access' configuration page. At the top, there is a navigation bar with tabs: Switching, Audio, Configuration, CEC, RS232, Interface, Network, and Access (selected). The main content area is titled 'Credentials' and contains a 'Password:' label followed by an input field containing 'admin' and a 'Confirm' button. Below this, there is a section titled 'Front Panel Lock' with two radio buttons: 'ON' (selected) and 'OFF'.

- Modify the login password.
- Lock or unlock the front panel buttons.

7.9 GUI Upgrade

Please visit at <http://192.168.0.178:100> for GUI online upgrade.

Type the username and password (the same as the GUI log-in setting, modified password will be available only after rebooting) to login the configuration interface. After that, click **Administration** in the source menu to get to **Upload Firmware** as shown below:

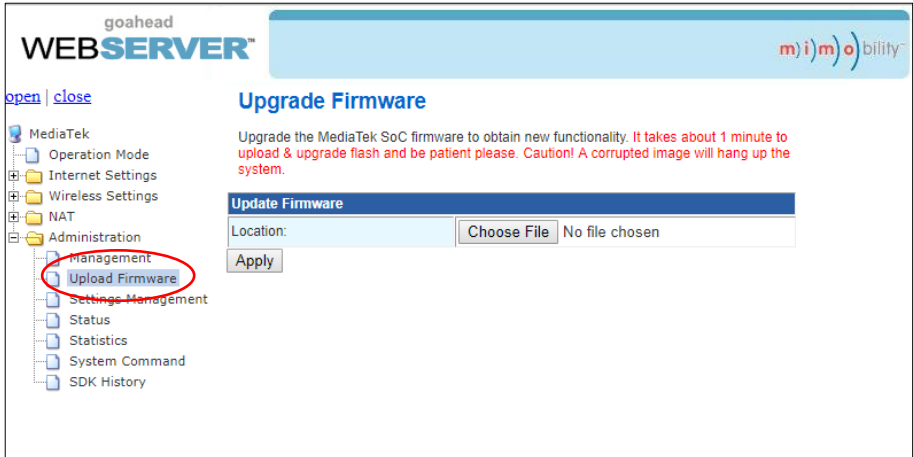

Select the desired update file and press **Apply**, it will start upgrading then.

8. RS232 Control

8.1 Installation/uninstallation of RS232 Control Software

- **Installation:** Copy the control software file to the control PC.
- **Uninstallation:** Delete all the control software files in corresponding file path.

8.2 Basic Settings

Firstly, connect H44AM with necessary input devices and output devices. Then, connect it with a PC installed RS232 control software. Double-click the software icon to run this software.

Here we take the software **CommWatch.exe** as example. The icon is showed as below:



The interface of the control software is showed as below:

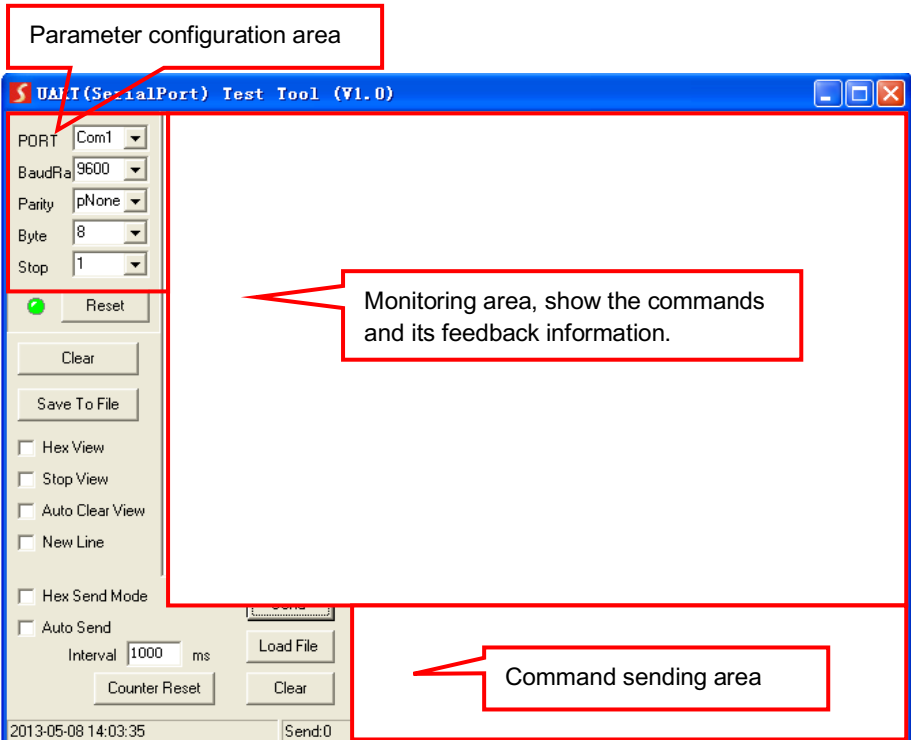

Set the parameters (baud rate, data bit, stop bit and parity bit) correctly to ensure reliable RS232 control.

8.3 RS232 Communication Commands



- Case-sensitive.
- “[, ”] in the commands are for easy recognition only and not necessary in real operations. Other symbols including “., “,” , “/”, “%”, “;”, “^”. are parts of the commands.
- Feedbacks listed in the column “Feedback Example” are only for reference, feedbacks may vary according to different operations.

Baud rate: 9600

Data bit: 8

Stop bit: 1

Parity bit: none

8.3.1 System Commands

Command	Function	Feedback Example
PowerON.	Power on	Power ON!
PowerOFF.	Power off	Power OFF!
/*Name.	Query the name of matrix	H44AM
/*Type.	Query the model of matrix	HDMI Matrix
/^Version.	Query the version of firmware	V1.0.0 CPLD:V1.0.0
RST.	Factory Default!	Factory Default!

8.3.2 Control Management

Command	Function	Feedback Example
DS[xx]ON.	Able output devices down-scaling function. [xx]=00~02, xx=01~02 is the corresponding number of output 3 or 4 port, if the xx =00, it means both output 3 and 4 ports.	HDMI OUT xx Down Scale ON!
DS[xx]OFF.	Disable output devices down-scaling function.	HDMI OUT xx Down Scale OFF!

4x4 HDMI 2.0 Matrix with Audio Matrix/ Downscaling/ AOC Supported

Command	Function	Feedback Example
	[xx]=00~02, xx=01~02 is the corresponding number of output 3 or 4 port, if the xx =00, it means both output 3 and 4 ports.	
@OUT[xx].	Able HDMI 5V of output port. [xx]=00~04, xx=01~04 is the number of output port, if the xx =00, it means all output ports.	Turn ON Output 01! Turn ON Output 02! Turn ON Output 03! Turn ON Output 04!
\$OUT[xx].	Disable HDMI 5V of output port. [xx]=00~04, xx=01~04 is the number of output port, if the xx =00, it means all output ports.	Turn OFF Output 01! Turn OFF Output 02! Turn OFF Output 03! Turn OFF Output 04!
OUT[xx]:[YY].	Output port select input port. [xx]=00~04, xx=01~04 is the number of output port, if the xx =00, it means all output ports. [YY]=01~04, YY=01~04 is the number of input port.	Output 01 Switch To In 04!

8.3.3 Query Commands

Command	Function	Feedback Example
GetGuiIP.	Query GUI IP	GUI_IP:192.168.0.178!
SetGuiIP:xxx.xxx.xxx.xxx.	Set GUI IP	SetGuiIP:192.168.0.178!
Baudratexxxx.	Set the baud rate of local serial port. xxxx=115200, 57600, 38400, 19200,or 9600	Baudrate9600. Set Local RS232 Baudrate Is 9600!
STA.	Query Status	GUI Or RS232 Query Status: 4x4 HDMI Matrix RD-MUH44A-H2 V1.0.0 Power ON! Front Panel UnLock! Local RS232

4x4 HDMI 2.0 Matrix with Audio Matrix/ Downscaling/ AOC Supported

Command	Function	Feedback Example
		Baudrate Is 9600! GUI_IP:192.168.0.17 8! ...
STA_POUT.	Query 5V Status of output port.	Turn ON Output 01! Turn ON Output 02! Turn ON Output 03! Turn ON Output 04!
STA_IN.	Query 5V Status of input port.	IN 1 2 3 4 LINK N N N N
STA_OUT.	Query HPD Status of output.	OUT 1 2 3 4 LINK N Y N N
STA_VIDEO.	Query the input source of output port.	Output 01 Switch To In 01! Output 02 Switch To In 02! Output 03 Switch To In 03! Output 04 Switch To In 04!
STA_DS.	Query Down-scaling Status	HDMI OUT 03 Down Scale ON! HDMI OUT 04 Down Scale ON!
STA_HDCP.	Query current using HDCP model of all output ports. 01-04 represents output port 1-4.	OUT 01 HDCP BYPASS! OUT 02 HDCP BYPASS! OUT 03 HDCP BYPASS! OUT 04 HDCP BYPASS!
STA_AUDIO.	Query audio switch and volume status of analog audio.	AUDIO Out 01 Switch To Video In 01! AUDIO Out 02 Switch To Video In 02! AUDIO Out 03 Switch To Video In 03! AUDIO Out 04 Switch To Video In 04!

4x4 HDMI 2.0 Matrix with Audio Matrix/ Downscaling/ AOC Supported

Command	Function	Feedback Example
PresetSta[xx].	Query the preset [xx]=01~09, xx=01~09 is the number of preset	Preset 01 Sta: Out 01 In 01! Out 02 In 01! Out 03 In 01! Out 04 In 01!
PresetSave[xx].	Save the preset	Preset 01 Sta: Out 01 In 01! Out 02 In 01! Out 03 In 01! Out 04 In 01!
PresetRecall[xx].	Preset recall	Preset 02 Recall: Output 01 Switch To In 02! Output 02 Switch To In 02! Output 03 Switch To In 02! Output 04 Switch To In 02!

8.3.4 Lock/unlock Commands

Command	Function	Feedback Example
Lock.	Lock the front panel buttons.	Front Panel Locked!
Unlock.	Unlock the front panel buttons.	Front Panel Unlock!

8.3.5 Audio Commands

Command	Function	Feedback Example
AUDIO[xx]:[YY].	SPDIF OUT and ANALOG OUT(They are same input audio source at one group) select which input audio source. [xx]=00~04 xx=01~04 is the number of the output port, if the xx=00, it means all output ports. [yy]=01~08	AUDIO Out 01 Switch To Video In 04!

4x4 HDMI 2.0 Matrix with Audio Matrix/ Downscaling/ AOC Supported

Command	Function	Feedback Example
	yy=01~04, it means de-embedded audio from HDMI1-4 input, if the yy=05~08, it means de-embedded audio from HDMI1-4 output.	
AVOLUME[xx]:[YY].	[xx]=00~04 xx=01~04 is the number of the Analog output port, if the xx=00, it means all Analog output ports. [YY]="V+" means volume up, [YY]="V-" means volume down, [YY]="MU" means Mute, [YY]="UM" means <u>U</u> nMute, [YY]=00-100 means setting volume.	Analog Out 01 Volume 61! Analog Out 02 Volume 61! Analog Out 03 Volume 61! Analog Out 04 Volume 61!

8.3.6 HDCP Compliance

Command	Function	Feedback Example
HDCP[xx]ON.	Force able and output HDCP 1.4. [xx]=00~04, xx=01~04 is the number of output port, if the xx =00, it means all output ports.	OUT 01 HDCP ON! OUT 02 HDCP ON! OUT 03 HDCP ON! OUT 04 HDCP ON!
HDCP[xx]OFF.	Force disable the output HDCP. [xx] =00~04, xx=01~04 is the number of output port, if the xx =00, it means all output ports.	OUT 01 HDCP OFF! OUT 02 HDCP OFF! OUT 03 HDCP OFF! OUT 04 HDCP OFF!
HDCP[xx]MAT.	Output HDCP follows the display. [xx] =00~04, xx=01~04 is the number of output port, if the xx =00, it means all output ports.	OUT 01 HDCP MAT Display! OUT 02 HDCP MAT Display! OUT 03 HDCP MAT Display! OUT 04 HDCP MAT Display!
HDCP[xx]PAS.	Output HDCP follows the value and status of input source device. [xx] =00~04, xx=01~04 is the number of output port, if	OUT 01 HDCP PASSIVE! OUT 02 HDCP PASSIVE!

4x4 HDMI 2.0 Matrix with Audio Matrix/ Downscaling/ AOC Supported

Command	Function	Feedback Example
	the xx =00, it means all output ports.	OUT 03 HDCP PASSIVE! OUT 04 HDCP PASSIVE!
HDCP[xx]BYP.	Output HDCP follows input HDCP. Input has HDCP, output is HDCP1.4. Input doesn't have HDCP, output is without HDCP. [xx]=00~04, xx=01~04 is the number of output port, if the xx =00, it means all output ports.	OUT 01 HDCP BYPASS! OUT 02 HDCP BYPASS! OUT 03 HDCP BYPASS! OUT 04 HDCP BYPASS!

8.3.7 EDID Management

Command	Function	Feedback Example
EDIDMInit.	Restore the factory default EDID data for each input.	All Input EDID Set Default!
EDIDUpgrade[xx].	Upgrade EDID via Serial Port <ul style="list-style-type: none"> [xx]=00~04 xx=01~04 is the number of input port(able EDID user-defined for corresponding HDMI input), if the xx=00, it means all input ports(able EDID user-defined for all HDMI inputs). <p>Note: EDID user-defined can be used once, if switch to another EDID or exit, it will not be saved.</p> <ul style="list-style-type: none"> [xx]=U. xx=U means user-defined for built-in EDID(It can be saved in machine for using at any time). <p>Note: It can user-defined only one built-in EDID, after finishing it, machine still use previous built-in EDID.</p> When received commands, machine will remind EDID file (.bin) to send within 10 seconds.	Input XX/User Define EDID Upgrade OK By RS232 Or GUI!

4x4 HDMI 2.0 Matrix with Audio Matrix/ Downscaling/ AOC Supported

Command	Function	Feedback Example
EDID/[xx]/[yy].	Input ports xx use built-in EDID yy [xx]=00~04 xx=01~04 is the number of the input port, if the xx=00, it means all input ports. [yy]=01~09 yy=01~08, it means built-in EDID that can not be user-defined, if the yy=09, it means user-defined EDID.	Input 03 EDID Upgrade OK By 01 Internal EDID!
EDIDGOUT[XX].	Read and print EDID of HDMI output, [XX]=01~04 is the number of the output port.	EDIDOUT04:
EDIDM[xx]B[yy].	Input port [yy] follows the EDID from output port [xx]. [xx]=01~04 xx=01~04 is the number of the output port. [yy]=00~04 yy=01~04 is the number of input port, if the yy=00, it means all input ports.	Input 01 EDID Upgrade OK By 04 EXT EDID!
/+[X]/[yy]:xxx.	Send serial data to local. [X]= 1--2400; 2--4800; 3--9600; 4--19200; 5--38400; 6--57600; 7--115200. [yy] means the output port that sent serial data, yy=01 means local output.	xxx.
EDIDSTA[xx].	Query EDID status of Input port. [xx]=00~04, xx=01~04 is the number of input port, if the xx=00, it means all input ports. Note: <ul style="list-style-type: none"> If built-in EDID09 is not user-defined, when querying it, the input port will use EDID6 Internal EDID instead. For example, send "EDID/03/09.", "EDIDSTA03.", and the result is "Input 03 EDID From 06 Internal EDID!". If built-in EDID09 has been 	Input 01 EDID From 01 Internal EDID! Input 02 EDID From 01 Internal EDID! Input 03 EDID From 01 Internal EDID! Input 04 EDID From 01 Internal EDID!

Command	Function	Feedback Example
	<p><i>user-defined, when querying it, the input port will use the user-defined EDID. For example, send "EDID/03/09.", "EDIDSTA03.", and the result is "Input 03 EDID From User Define EDID!".</i></p> <ul style="list-style-type: none"> <i>If directly user-define the port EDID, when querying it, the input port will use the user-defined EDID. For example, send "EDIDSTA03.", and the result is "Input 3 EDID From User Define EDID!"</i> 	

8.3.3 CEC Control

If the input sources, HDBaseT output devices and local HDMI output devices are supports CEC, they can be controlled by sending the following command instead of IR remote.

CEC[I/O][AA][BB][CC][DD].

- The “[I]” represents the input port. The “[O]” represents the output port.
- The “[AA]” represents the port number. The HDMI input ports are 01~04. The HDMI output ports are 01~04.
- The “[AA]” is “FF” for sending command to all input or output ports.
- The “[BB]” represents the device type (e.g. TV: 40/20/80; Blu-ray DVD: 04/08).
- The “[CC]” represents the CEC function type (e.g. “44”: Remote control).
- The “[DD]” represents the specific command from the table below.

✓ **Control the input source:**

Command	Description	Command Example and Response
CECI[AA][BB][CC]00.	Confirm operation (Enter).	CECI02044400
		CEC Input 02 Send Success!
CECI[AA][BB][CC]01.	UP direction.	CECI01044401.
		CEC Input 01 Send Success!
CECI[AA][BB][CC]02.	DOWN direction.	CECI01044402.

4x4 HDMI 2.0 Matrix with Audio Matrix/ Downscaling/ AOC Supported

		CEC Input 01 Send Success!
CECI[AA][BB][CC]03.	LEFT direction.	CECI03044403.
		CEC Input 03 Send Success!
CECI[AA][BB][CC]04.	RIGHT direction.	CECI03044404.
		CEC Input 03 Send Success!
CECI[AA][BB][CC]09.	Back to submenu.	CECI03044409.
		CEC Input 03 Send Success!
CECI[AA][BB][CC]0A.	Enter main menu.	CECI0304440A.
		CEC Input 03 Send Success!
CECI[AA][BB][CC]0D.	Exit menu.	CECI0204440D.
		CEC Input 02 Send Success!
CECI[AA][BB][CC]6D.	Power on.	CECI0204446D.
		CEC Input 02 Send Success!
CECI[AA][BB][CC]6C.	Power off.	CECI0204446C.
		CEC Input 02 Send Success!

✓ Control the output display device:

Command	Description	Command Example and Response
CECO[AA][BB][CC]41. .	Volume up.	CECO04404441.
		CEC Output 05 Send Success!
CECO[AA][BB][CC]42. .	Volume down.	CECO04404442.
		CEC Output 05 Send Success!
CECO[AA][BB][CC]43. .	Mute	CECO04404443.
		CEC Output 05 Send Success!
CECO[AA][BB]04.	Power on.	CECO038004.
		CEC Output 03 Send Success!
CECO[AA][BB]36.	Power off.	CECO038036.
		CEC Output 03 Send Success!

9. Firmware Upgrade

Please follow the steps as below to upgrade firmware by the **FIRMWARE** port on the rear panel:

- 1) Prepare the latest upgrade file and rename it as "08010000.APP" on PC.
- 2) Power off the switcher, and connect the **FIRMWARE** port of switcher to the PC with USB cable.
- 3) Power on the switcher, and then the PC will automatically detect a U-disk named of "BOOTDISK".
- 4) Double-click the U-disk, a file named of "READY.TXT" would be showed.
- 5) Directly copy the latest upgrade file 08010000.APP (.bin) to the "BOOTDISK" U-disk.
- 6) Reopen the U-disk to check the filename "READY.TXT" whether automatically becomes "SUCCESS.TXT", if yes, the firmware was updated successfully, otherwise, the firmware updating is fail, the name of upgrade file (.bin) should be confirm again, and then follow the above steps to update again.
- 7) Remove the USB cable after firmware upgrade.
- 8) After firmware upgrade, the switcher should be restored to factory default by sending command.

10. Troubleshooting and Maintenance

Problems	Potential Causes	Solutions
Color losing or no video signal output	The connecting cables may not be connected correctly or it may be broken.	Check whether the cables are connected correctly and in working condition.
	Fail or loose connection.	Make sure the connection is good
No output image when switching	No signal at the input / output end.	Check with oscilloscope or multimeter if there is any signal at the input/ output end.
	Fail or loose connection.	Make sure the connection is good.
	Input source is with HDCP while the HDCP compliance is switched off.	Send command /%[Y]/[X]:1. or change HDCP compliance status in GUI.
	The display doesn't support the input resolution.	Switch for another input source or enable the display to learn the EDID data of the input.
Cannot control the device via front panel buttons	Front panel buttons are locked.	Send command /%Unlock; or select unlock in GUI interface to unlock.
Cannot control the device via IR remote	The battery has run off.	Change for new battery.
	The IR remote is broken.	Send it to authorized dealer for repairing.
	Beyond the effective range of the IR signal or not pointing at the IR receiver.	Adjust the distance and angle and point right at the IR receiver.
	The IR receiver connected to IR IN port is not with carrier.	Change for an IR receiver with carrier.
Power Indicator remains off when powered on	Fail or loose power connection.	Check whether the cables are connected correctly.

4x4 HDMI 2.0 Matrix with Audio Matrix/ Downscaling/ AOC Supported

EDID management does not work normally	The HDMI cable is broken at the output end.	Change for another HDMI cable which is in good working condition.
There is a blank screen on the display when switching	The display does not support the resolution of the video source.	Switch again.
		Manage the EDID data manually to make the resolution of the video source automatically compliant with the output resolution.
Cannot control the device by control device (e.g. a PC) through RS232 port	Wrong connection.	Check to ensure the connection between the control device and the unit
	Wrong RS232 communication parameters.	Type in correct RS232 communication parameters: Baud rate:9600; Data bit: 8; Stop bit: 1; Parity bit: none
	Broken RS232 port.	Send it to authorized dealer for checking.

Note: If your problem persists after following the above troubleshooting steps, seek further help from authorized dealer or our technical support.

11. Customer Service

The return of a product to our Customer Service implies the full agreement of the terms and conditions hereinafter. These terms and conditions may be changed without prior notice.

1) Warranty

The limited warranty period of the product is fixed three years.

2) Scope

These terms and conditions of Customer Service apply to the customer service provided for the products or any other items sold by authorized distributor only.

3) Warranty Exclusion

- Warranty expiration.
- Factory applied serial number has been altered or removed from the product.
- Damage, deterioration or malfunction caused by:
 - ✓ Normal wear and tear.
 - ✓ Use of supplies or parts not meeting our specifications.
 - ✓ No certificate or invoice as the proof of warranty.
 - ✓ The product model showed on the warranty card does not match with the model of the product for repairing or had been altered.
 - ✓ Damage caused by force majeure.
 - ✓ Servicing not authorized by distributor.
 - ✓ Any other causes which does not relate to a product defect.
- Shipping fees, installation or labor charges for installation or setup of the product.

4) Documentation

Customer Service will accept defective product(s) in the scope of warranty coverage at the sole condition that the defeat has been clearly defined, and upon reception of the documents or copy of invoice, indicating the date of purchase, the type of product, the serial number, and the name of distributor.

Remarks: Please contact your local distributor for further assistance or solutions.